

User Manual

PV Optimizer

SP1200D/SP1400D



All Rights Reserved

All Rights Reserved

No part of this document can be reproduced in any form or by any means without the prior written permission of Sungrow Power Supply Co., Ltd (hereinafter "SUNGROW").

Trademarks

SUNGROW and other SUNGROW trademarks used in this manual are owned by SUNGROW.

All other trademarks or registered trademarks mentioned in this manual are owned by their respective owners.

Software Licenses

- It is prohibited to use data contained in firmware or software developed by SUNGROW, in part or in full, for commercial purposes by any means.
- It is prohibited to perform reverse engineering, cracking, or any other operations that compromise the original program design of the software developed by SUNGROW.

About This Manual

This manual gives an introduction to the PV optimizer as well as instructions on its installation, operation, and maintenance, yet not all-encompassing regarding the information about the PV system. You may visit www.sungrowpower.com or the website of the device manufacturer for more information.

Validity

This manual applies to the following product:

- SP1200D
- SP1400D

It is referred to as "optimizer" hereinafter unless otherwise specified.

Target Group

This manual is intended for qualified technical persons who are responsible for the optimizer installation, operation, and maintenance and users who need to check its parameters.

The installation must only be performed by qualified technical persons. Qualified technical persons must:

- Have certain electrical wiring, electronic, and mechanical expertise, and be familiar with electrical and mechanical schematics;
- Have received professional training in the installation and commissioning of electrical equipment;
- Be able to respond quickly and effectively to dangers or emergencies that may occur during the process of installation and commissioning;
- Be familiar with applicable local standards and relevant safety regulations on electrical systems;
- Read through this manual carefully and have a good understanding of the relevant safety instructions.

How to Use This Manual

Read through this manual carefully before using the product, and keep it properly in an easy-to-reach place.

The manual may be updated and revised from time to time, however, there still might be slight deviation from the real product or errors. In such cases, the actual product you have purchased should take precedence. You can find the latest version of the manual at support.sungrowpower.com or reach your sales for it.

Security Declaration

For details on the product's network security vulnerability response process and vulnerability disclosure, please visit the following website: <https://en.sungrowpower.com/security-vulnerability-management>.

For more information on network security, please refer to the user manual of the communication module or the Data Logger that comes with the product.

Symbols in the Manual

To ensure the safety of life and property for users when using the product and to improve the efficiency of product use, the manual provides relevant information, which are highlighted by the following symbols.

Symbols used in this manual are listed below. Please review carefully for better use of this manual.

DANGER

Indicates an imminently hazardous situation which, if not avoided, will result in death or serious injury.

WARNING

Indicates a moderately hazardous situation which, if not avoided, will result in death or serious injury.

CAUTION

Indicates a slightly hazardous situation which, if not avoided, may result in minor or moderate injury.

NOTICE

Indicates a potential hazard which, if not avoided, will result in device malfunction or property damage.



“NOTE” indicates supplementary information, emphasis on specific points, or tips related to the use of the product that might help to solve your problems or save your time.

Contents

All Rights Reserved.....	I
About This Manual.....	II
1 Safety Instructions.....	1
1.1 Unpacking and Inspection.....	1
1.2 Installation Safety.....	1
1.3 Electrical Connection Safety.....	2
1.4 Operation Safety.....	3
1.5 Maintenance Safety.....	3
1.6 Disposal Safety.....	4
2 Product Description.....	5
2.1 System Introduction.....	5
2.2 Optimizer Introduction.....	6
2.3 Signs on the Product.....	7
2.4 Configuration Principles.....	8
2.5 Application Scenarios.....	8
3 Unpacking and Storage.....	10
3.1 Unpacking and Inspection.....	10
3.2 Optimizer Storage.....	10
4 Mechanical Mounting.....	12
4.1 Installation Site Selection.....	12
4.2 Installation Tools.....	13
4.3 Optimizer Mounting.....	13
4.3.1 Installation Scenarios.....	14
4.3.2 Mounted on PV Module (Clip-on).....	14
4.3.3 Mounted on Aluminum Guide Rail.....	15
4.3.4 Mounted on Steel Guide Rail (T-head bolt).....	16
4.3.5 Mounted on Steel Guide Rail (Bolt Assembly).....	17
5 Electrical Connection.....	18
5.1 Safety Instructions.....	18
5.2 Terminal Description.....	19
5.3 Cable Preparation.....	20
5.4 Optimizer Connection to PV Module.....	21
5.5 Wiring Notices.....	26
6 Commissioning.....	28

6.1 Inspection Before Commissioning.....	28
6.2 Set Optimizer Physical & Logical Layouts.....	28
6.2.1 Optimizer Layout Settings (iSolarCloud).....	28
6.3 PLC Communication Setup.....	29
6.4 View Optimizer Layout.....	30
6.4.1 Check Optimizer Status.....	30
6.4.2 View Layout.....	32
6.4.3 View Module Information.....	34
7 Optimizer Decommissioning, Dismantling, and Disposal.....	36
7.1 Decommission the optimizer.....	36
7.2 Dismantle the optimizer.....	36
7.3 Dispose of the optimizer.....	37
8 Troubleshooting and Maintenance.....	38
8.1 Troubleshooting.....	38
8.2 Maintenance.....	41
8.2.1 Maintenance Notices.....	41
8.2.2 Routine Maintenance.....	41
8.2.3 Rapid Shutdown.....	42
8.2.4 Replace the optimizer.....	42
9 Appendix.....	45
9.1 Technical Data.....	45
9.2 Quality Assurance.....	47
9.3 Contact Information.....	48

1 Safety Instructions

When installing, commissioning, operating, and maintaining the device, strictly observe relevant safety instructions. Incorrect operation or work may cause:

- Injury or death to the operator or a third party.
- Damage to the device and other properties.

Strictly follow the safety instructions stated in the manual to avoid the hazards mentioned above.



- The safety instructions in this manual are only supplements and cannot cover all the precautions that should be followed. Perform operations considering actual on-site conditions.
- SUNGROW shall not be held liable for any damage caused by violation of general safety operation requirements, general safety standards, or any safety instruction in this manual.
- When installing, operating, and maintaining the device, comply with local laws and regulations. The safety precautions in this manual are only supplements to local laws and regulations.

1.1 Unpacking and Inspection

WARNING

Check all safety signs, warning labels, and nameplates on products. The safety signs, warning labels and nameplates must be clearly visible and cannot be removed or covered before the product is decommissioned.

NOTICE

After receiving the product, check whether the appearance and structural parts of the device are damaged, and check whether the product received is consistent with the order. If there are problems with the above inspection items, do not install the device and contact SUNGROW in time.

1.2 Installation Safety

DANGER

Make sure there is no electrical connection before installation.

NOTICE

Before operating the product, please check and ensure that tools to be used have been maintained regularly.

1.3 Electrical Connection Safety

⚠ DANGER

Before electrical connections, make sure that the optimizer is not damaged. Otherwise, it may lead to dangers!
Before electrical connections, make sure that all switches connected to the optimizer are set to "OFF". Otherwise, it may lead to electric shocks!
The optimizer does not support hot swapping. Do not add or remove an optimizer with power on, otherwise, the optimizer may get damaged!

⚠ DANGER

Hazardous voltages on the PV string when it is exposed to sunlight!

- Operators must wear proper personal protective equipment during electrical connections.
- Check and confirm that the DC cables are voltage-free using a measuring instrument before touching them.
- Observe all the safety instructions listed in the documents for the PV string and other relevant documents.

⚠ DANGER

- Be sure to use specialized insulated tools during wiring.
- Observe the warning signs on the optimizer, and perform operations by strictly following the corresponding safety instructions.
- Observe all the safety instructions listed in this manual and other relevant documents for the product.

⚠ WARNING

Improper wiring may damage the product, and such damage will not be covered by the warranty.

- Electrical connections must only be performed by qualified technical persons.
- The specification of cables used in the PV system should meet the relevant requirements. The cables should be well-insulated and firmly connected.

⚠ WARNING

Check the positive and negative terminals of the PV module cables first. Connect the PV module cables to the DC terminals on the product only after confirming that the polarity is correct.

During the installation and operation of the optimizer, ensure that the positive or negative of the PV string is not short-circuited to the ground. Otherwise, the product may be damaged, and such damage will not be covered by warranty.

NOTICE

Wiring must be done in compliance with the applicable local grid regulations and relevant safety instructions specified for the PV string.

1.4 Operation Safety

⚠ DANGER

- Do not plug or pull out any connector on the optimizer when it is running.
- Do not disassemble the optimizer or remove any of its parts or components when it is running. Otherwise, it may lead to electric shocks.
- Do not touch the optimizer when it is running. Otherwise, it may cause burns.
- Do not take other actions, such as setting parameters, during the process of firmware update, to avoid update failure.

1.5 Maintenance Safety

⚠ DANGER

Risk of personal injury or device damage due to improper servicing!

- Be sure to use specialized insulated tools when performing high-voltage operations.
- Before maintenance, power off the input and output sides first, then test the voltage and current using the specialized measuring instrument. Maintenance can be carried out by qualified persons who wear proper protective equipment only after confirming that no voltage or current is present.
- Danger of burns due to a hot surface still exists even if the product has stopped running. Perform operations on the product wearing protective gloves after it cools down.

⚠ WARNING

In case of a fault in the product during its operation, before powering on again, make sure the fault has been removed. Otherwise, it may cause the influence of the fault to spread or device damages.

⚠ CAUTION

To prevent irrelevant personnel from operating the product by mistake or other accidents, please set up highly visible warning signages around the product or fence off a warning zone.

NOTICE

To minimize the risk of electric shocks, do not perform maintenance operations that are not specified in this manual. If necessary, contact **SUNGROW** for maintenance. Losses arising from failure to observe this instruction will not be covered by warranty.

1.6 Disposal Safety

⚠ WARNING

Please scrap the product in accordance with relevant local regulations and standards to avoid property losses or casualties.

2 Product Description

2.1 System Introduction

SP1200D/SP1400D optimizer is mainly used to adjust the voltage and current of each PV module in real time to track the maximum power point of each module, thus improving the power generation capacity of the PV system. It can also realize module-level shutdown, module-level IV curve scanning and automatic physical recognition.

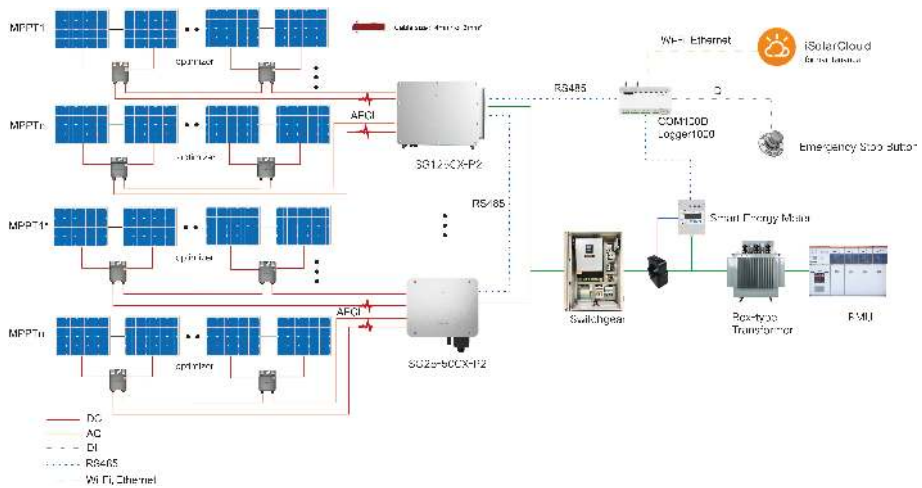

Figure 2-1 Application of optimizers in Commercial and Industrial System

NOTICE

The SP1200D/SP1400D optimizer is not compatible with third-party inverters.

2.2 Optimizer Introduction

Product Model

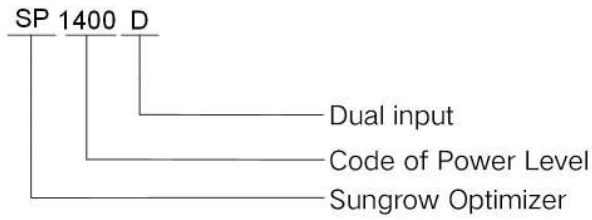

Figure 2-2 Product Model

External Design

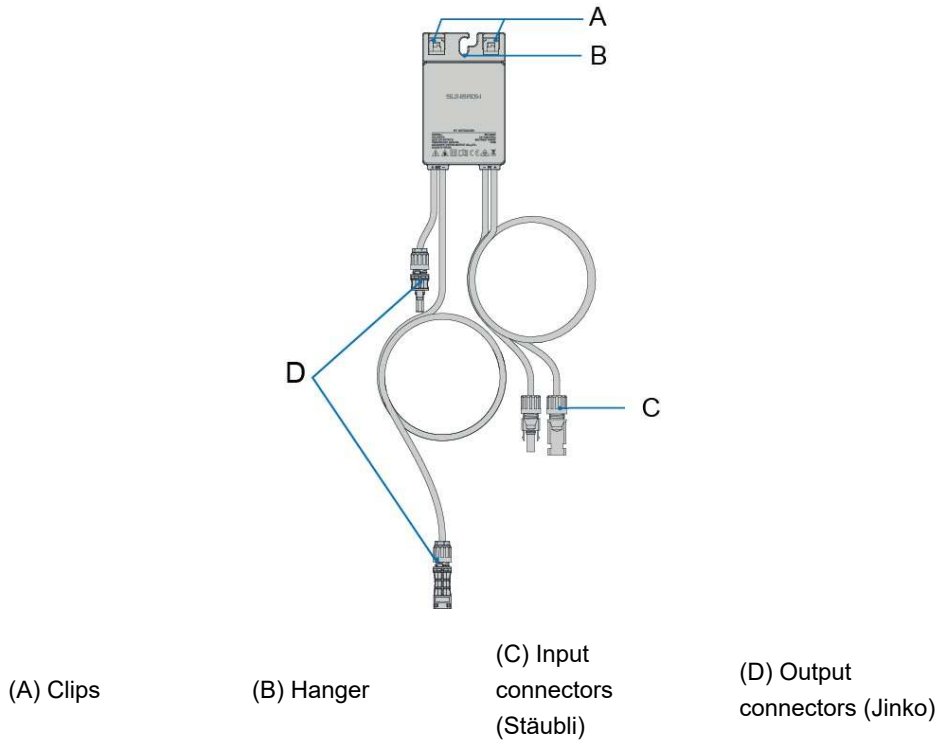
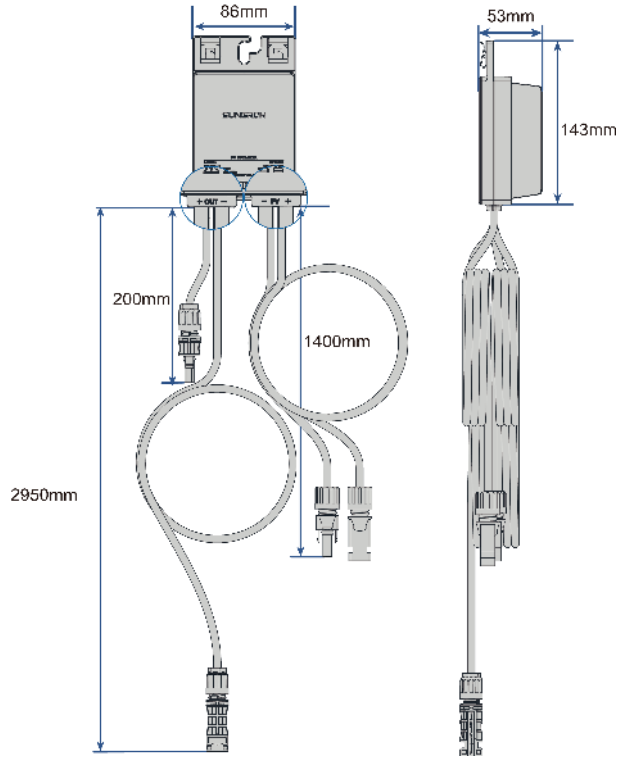

Figure 2-3 External Design



*The figure here is for illustration only and the real product may differ.

Dimensions



2.3 Signs on the Product

Sign	Description
	Do not dispose of the optimizer as household waste.
	Read the manual before performing any operation on the optimizer.
	CE compliance mark. EU/EEA imports.
	RCM compliance mark.
	Burn hazard due to the hot surface that may exceed 60°C.

Sign	Description
	Beware of electric shocks.
	Equipment protected by double insulation or reinforced insulation.

2.4 Configuration Principles

Compatible inverter models

This optimizer can be used in conjunction with SUNGROW SG25/30/33/40/50CX-P2 and SG125CX-P2 inverters.

Number of optimizers supported by communication device

The WiNet-S2 supports the use of up to 240 optimizers, while the Logger1000A and the Logger1000B support up to 4900 optimizers.

Requirements for PV module connection

- Up to 25 optimizers can be installed in each PV string.
- The number of PV modules connected to optimizers in each PV string must not exceed the maximum number of modules allowed in one string by the inverter.
- The maximum open-circuit voltage of each PV string must not exceed 1100V.

2.5 Application Scenarios

Full Deployment Scenario

Full deployment scenario: All PV modules connected to the inverter are equipped with optimizers.

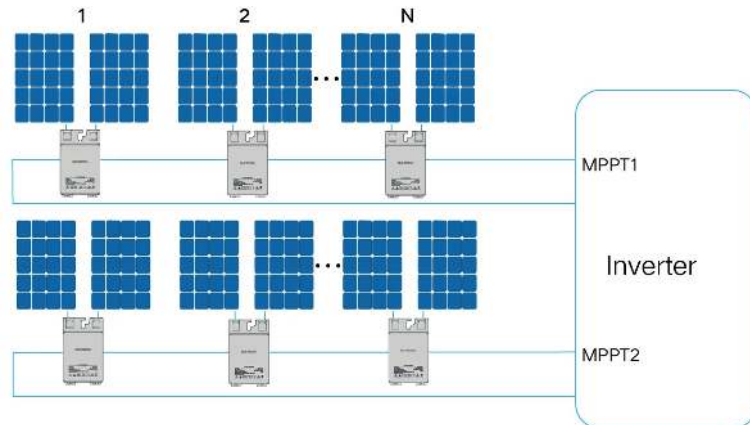

Figure 2-4 Optimizers Installed for All PV Modules



SP1200D and SP1400D do not support partial deployment.

3 Unpacking and Storage

3.1 Unpacking and Inspection

The device is thoroughly tested and strictly inspected before delivery. Nonetheless, damage may still occur during shipping. For this reason, please conduct a thorough inspection after receiving the device.

- Check the packing case for any visible damage.
- Check the inner contents for damage after unpacking.

Contact SUNGROW or the transport company in case of any damage or incompleteness, and provide photos to facilitate services.

Do not dispose of the original packing case. It is recommended to store the device in the original packing case when the product is decommissioned.

NOTICE

**After receiving the product, check whether the appearance and structural parts of the device are damaged, and check whether the packing list is consistent with the actual order. If there are problems with the above inspection items, do not install the device and contact SUNGROW in time.
If any tool is used for unpacking, be careful not to damage the product.**

3.2 Optimizer Storage

If the optimizer is not to be put into use immediately, store it properly by following the below requirements.

- Repack it using the original packing crate.
- The temperature for optimizer storage is -40°C to 85°C and the humidity is 0% to 95% (without condensation).
- If the optimizer crates are stacked, the number of layers in a stack should not exceed the maximum layers of stack indicated on the crate.
- The packing crate cannot be tilted or turned upside down.
- Do not store the optimizer in places prone to direct sunlight, rain, or strong electric field.
- Do not store the optimizer in places with items that may affect or damage it.
- The optimizer should be kept in a clean, dry, and ventilated place and protected from the intrusion of dust and moisture.
- Do not store the optimizer in places with corrosive chemicals or prone to damages by rodents or pests.

- Carry out routine inspections. Inspection should be conducted at least once every six months. Re-pack the optimizer in time if any damage caused by pests or animals is found.
- If the optimizer has been stored for more than a year, ask qualified personnel to inspect and test it before putting it into use again.

NOTICE

Store the optimizer according to the storage requirements. Device damage arising from failure to observe the storage requirements will not be covered by warranty.

4 Mechanical Mounting

WARNING

Respect all local standards and requirements during mechanical installation.

4.1 Installation Site Selection

A good location is critical to the safe operation, long service life, and good performance of the optimizer.

- The optimizer is IP68 rated.
- It should be installed at a position convenient for electrical connection, operation, and maintenance.

Installation Environment Requirements

- Install the optimizer in a place with shelter, so as to prevent it from getting impacted by direct sunlight and severe weather (e.g. snow, rain, and lightning). The optimizer will derate in high temperatures for self-protection. If installed in a place directly exposed to sunlight, as the temperature rises, the optimizer may witness power reduction.
- Do not install the device in an environment with flammables, explosives, or smoke.
- Do not install the device in a place prone to water leak, e.g., under the air-conditioner vent, the air vent, or the cable outlet window of the machine room, so as to prevent device damage or short circuit caused by intrusion of water.
- Do not install the device in a place with corrosives such as corrosive gas and organic solvent, etc.
- Do not install the device in an environment contaminated with chemicals such as halogen and sulfide.
- Do not install the device in an environment with vibration and strong electromagnetic field. Strong-magnetic-field environments refer to places where magnetic field strength measures over 30A/m.
- The device must be out of reach of children.
- Protect the device from direct sunlight, rain, or snow to prolong its service life. A place with shelter is recommended for installing the device.
- Good heat dissipation is very important to the device. Please install it in a ventilated environment.
- The average temperature approximately 1 m around the device should be taken as its operating temperature. The temperature and humidity should meet the requirements below:

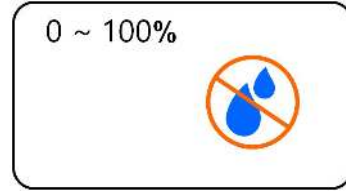
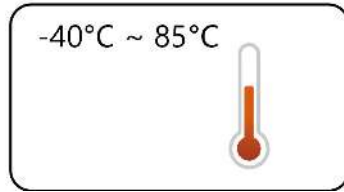

4.2 Installation Tools

Installation tools include but are not limited to the following recommended ones. Use other auxiliary tools on site as needed.



Protective gloves



Insulated shoes



Tape



Utility knife



Wire cutter



Wire strippers



Crimping tool



Socket wrench
(M8)



Multimeter



Open-end wrench
kit

4.3 Optimizer Mounting

Prerequisite

The optimizer supports clip-on mounting and bolt mounting. Please choose a mounting method based on the on-site conditions.

4.3.1 Installation Scenarios

Clip-on mounting

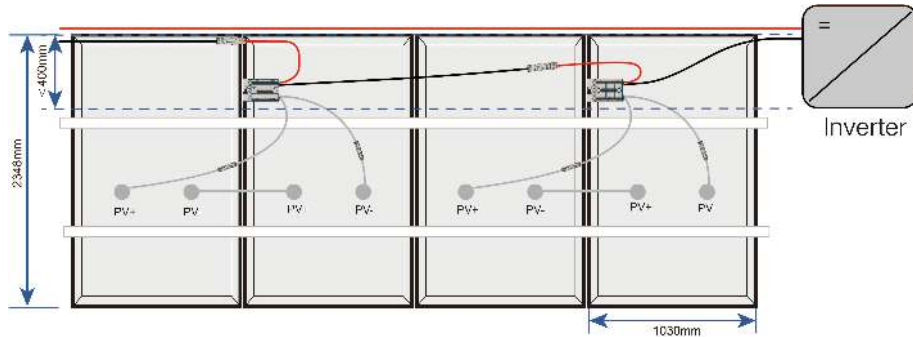

Bracket mounting

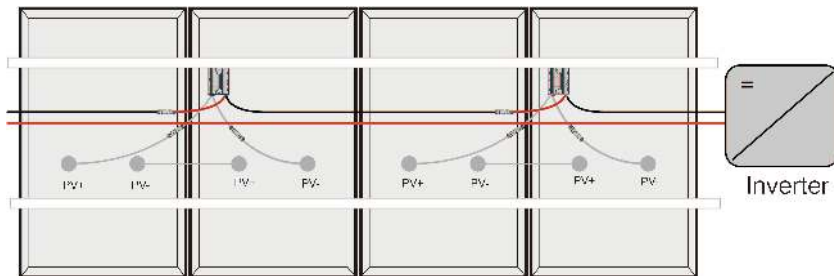

NOTICE

- Before installation, select the appropriate optimizer variant and decide the installation and arrangement schemes based on the actual situation, to ensure that the optimizer can be connected to PV modules and adjacent optimizers normally.
- The mounting and wiring should be performed in compliance with local laws, regulations, safety standards, and installation specifications. If the cable is too long, do not let it hang down to the ground. You can secure it nearby to the bracket or the edge of the module.

4.3.2 Mounted on PV Module (Clip-on)

Step 1 Clip the optimizer into the back of the PV module, as shown in the figure below. Keep the optimizer parallel to the PV module when clipping it on.



NOTICE

- Ensure that the optimizer is installed facing the back of the module. Otherwise, the clips may get damaged.

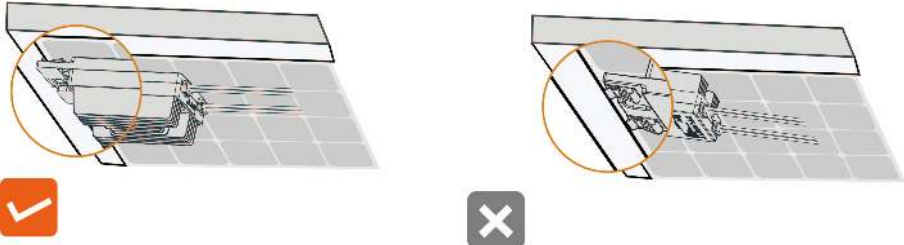

- Do not apply force to the optimizer in a direction vertical to its clips when clipping it onto the module. Otherwise, the clips may get damaged.

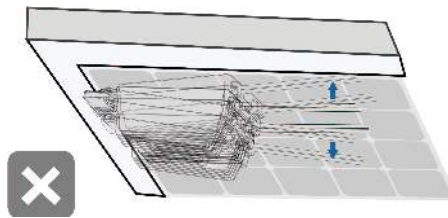

- Do not clip the optimizer into holes in the module frame during installation. Otherwise, you may not be able to remove the optimizer again and its clips may get damaged.

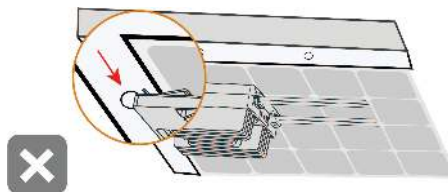

- It is recommended to install optimizers on the same side of modules.
- Do not clip and remove the optimizer repeatedly. Otherwise, the clips may become loose and thus cannot function properly.

--End

4.3.3 Mounted on Aluminum Guide Rail

Step 1 It is recommended to use M8×25 T-head bolt (not included in the scope of delivery). Slide the T-head bolt into the groove in the aluminum guide rail.



Step 2 Hang the optimizer to the T-head bolt by its hanger, then fit the nut onto the bolt using a socket wrench, to secure the optimizer to the aluminum guide rail. They are connected together in the order of nut, hanger, and then T-head bolt.

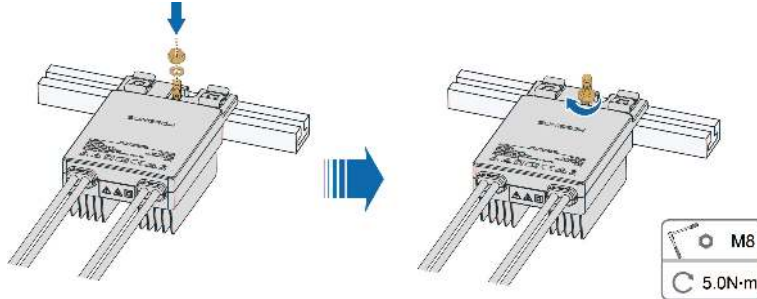

⚠ WARNING

- During installation, make sure the metal clips do not get in contact with the bracket.
- Install the optimizer with its back tightly against the bracket. Installing it from the opposite direction may damage the optimizer and such damage will not be covered by warranty.
- Ensure the optimizer is installed in the correct orientation. Failing to do so may impede proper installation of the PV module and hence result in rework.

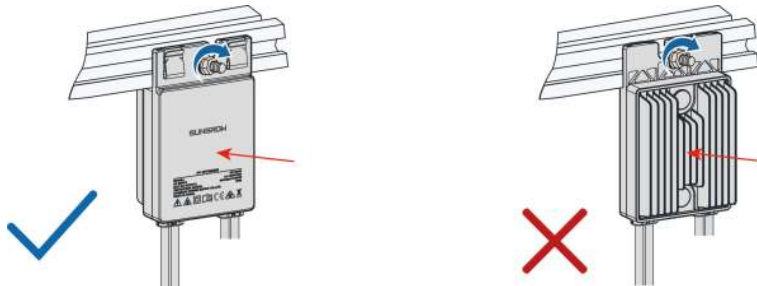

--End

4.3.4 Mounted on Steel Guide Rail (T-head bolt)

Step 1 It is recommended to use M8×25 T-head bolt (not included in the scope of delivery). Insert the T-head bolt into the guide rail, and turn it 90°.

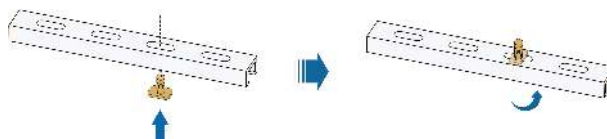

Step 2 Hang the optimizer to the T-head bolt by its hanger, then fit the nut onto the bolt using a socket wrench, to secure the optimizer to the steel guide rail. They are connected together in the order of nut, hanger, and then T-head bolt.

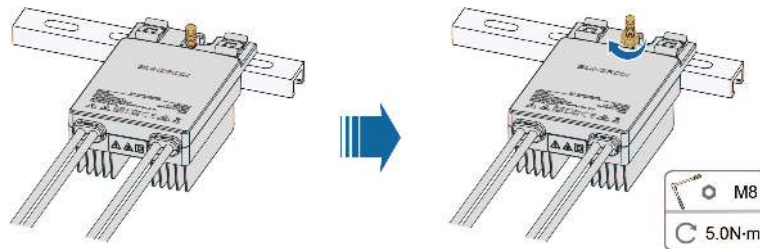

--End

4.3.5 Mounted on Steel Guide Rail (Bolt Assembly)

Step 1 It is recommended to use the M8×25 bolt assembly (not included in the scope of delivery). Insert the bolt through the flat washer and spring washer into the guide rail.

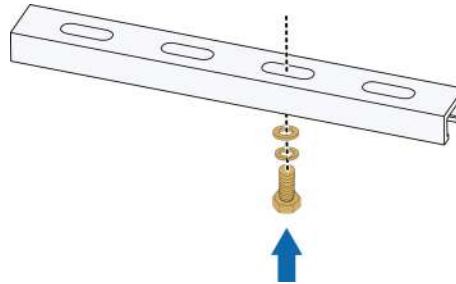

Step 2 Hang the optimizer to the bolt by its hanger, then fit the nut onto the bolt using a socket wrench, to secure the optimizer to the steel guide rail. They are connected together in the order of nut, hanger, spring washer, flat washer, and then bolt.

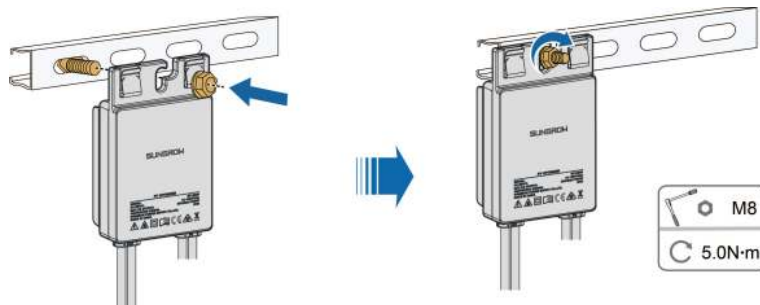

--End

5 Electrical Connection

5.1 Safety Instructions

DANGER

Hazardous voltages on the PV string when it is exposed to sunlight!

- Operators must wear proper personal protective equipment during electrical connections.
- Check and confirm that the DC cables are voltage-free using a measuring instrument before touching them.
- Observe all the safety instructions listed in the documents for the PV string and other relevant documents.

DANGER

- Before electrical connections, make sure that the optimizer is not damaged. Otherwise, it may lead to dangers!
- Before electrical connections, make sure that all switches connected to the optimizer are set to "OFF". Otherwise, it may lead to electric shocks!
- The optimizer does not support hot swapping. Do not add or remove an optimizer with power on, otherwise, the optimizer may get damaged!
- Check that the input and output cables of the optimizers are all connected correctly (that is, the PV module should not be connected to the output side of the optimizer, while the input side of the optimizer should not be connected to the inverter side or other optimizers in the system); if the connection is wrong, correct it in time. Add and activate the optimizers in the software only after confirming that the connections are all correct. Otherwise, the improperly wired optimizer may get damaged, and such damage will not be covered by warranty.

WARNING

Improper wiring may damage the product, and such damage will not be covered by the warranty.

- Electrical connection must only be performed by qualified technical persons.
- Operators must wear proper personal protective equipment during electrical connections.
- The specification of cables used in the PV system should meet the relevant requirements. The cables should be well-insulated and firmly connected.

NOTICE

All electrical connections must be done in compliance with the applicable local and national/regional electrical standards.

- Cables used by the user should comply with the requirements of local laws and regulations.

NOTICE

Wiring must be done in compliance with the applicable local grid regulations and relevant safety instructions specified for the PV string.



The wire colors in the figures in this manual are for reference only. Please select cables according to local cable codes.

5.2 Terminal Description

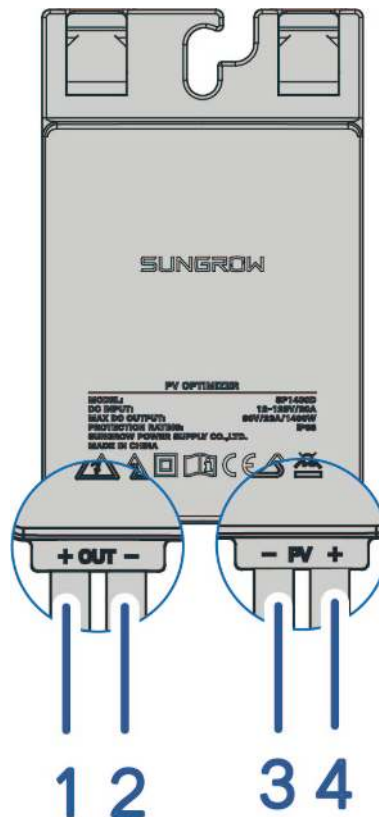

Figure 5-1 Internal Terminals

No	Mark	Description
1	OUT+	Positive output.
2	OUT-	Negative output.
3	PV-	Negative input.
4	PV+	Positive input.

5.3 Cable Preparation

In the process of optimizer wiring, if the main cable falls short and the connectors cannot reach each other, an extension cable is needed.

NOTICE

- **When preparing an extension cable, pay attention to the selection of DC connectors at the two ends of the cable. Ensure that the connectors at both ends of the cable are consistent with those to which they will be attached, thereby guaranteeing a reliable connection.**
- **Make sure the DC connectors of the cable are identical to or compatible with the connectors on the product. Otherwise, it may lead to damage and such damage will not be covered by the warranty.**
- **Use cables with a cross-sectional area of 4 mm² and 6 mm²; cables with a cross-sectional area of 10 mm² are not supported.**

Step 1 Strip the insulation layer of the DC cable by a length (L) of about 7–8 mm.

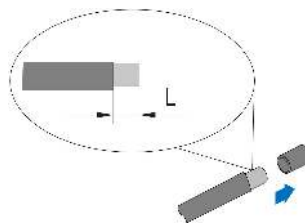

Step 2 Crimp the terminal onto the cable.

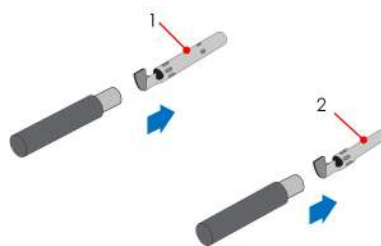

(1) Cold-pressed terminal, positive

(2) Cold-pressed terminal, negative

NOTICE

When making an extension cable, ensure that the cold-pressed terminals are of the same model as the DC connector, otherwise, the connection may be unreliable and the DC connector may be burned.

Step 3 Lead the cable through the cable gland, and insert the cold-pressed terminal into the insulator until it snaps into place. Pull gently the cable backward to make sure the connection is secure. Then, tighten the cable gland and the insulator at a torque of 2.5–3 N.m.

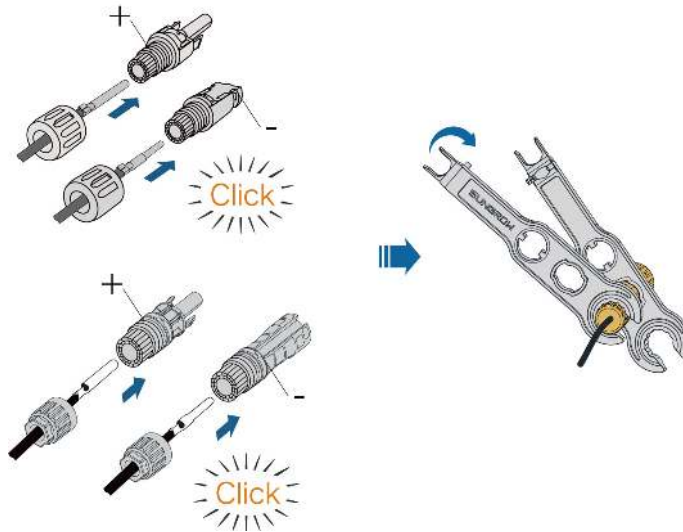

Step 4 Insert the positive DC connector into the corresponding negative DC connector, until there is an audible "click".

--End

5.4 Optimizer Connection to PV Module

Prerequisite

⚠ DANGER

Danger of electric shocks!
Pay attention! PV arrays carry hazardous high voltages when exposed to sunlight.
Ensure all cables are voltage-free before performing electrical operations.

⚠ WARNING

- Ensure the PV array is well insulated to the ground before connecting an optimizer to a PV module.



Shorten the distance between the positive and negative cables of the optimizer according to on-site conditions to reduce electromagnetic interference.

Step 1 Connect the PV+ and PV- cables of the optimizer respectively to the positive and negative terminals in the junction box of the PV module.

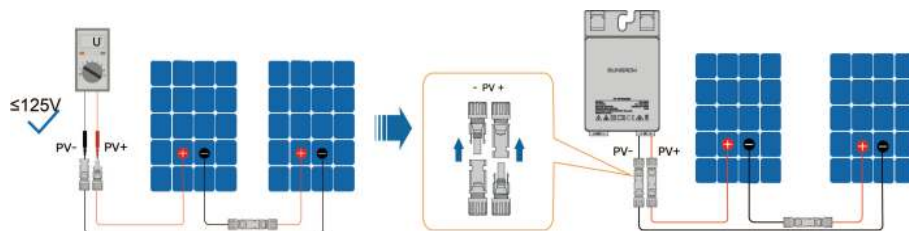

NOTICE

- Before connecting the PV module to the optimizer's input terminals, test the output voltage of the module using a multimeter and make sure it is below 125V. Optimizer or PV module damage caused by failing to observe this instruction will not be covered by the warranty.
- Do not connect the PV module to the OUT+ and OUT- of the optimizer. Otherwise, the optimizer or PV module will be damaged, and such damage will not be covered by warranty.

Step 2 Connect the positive probe of a multimeter to the OUT+ of the optimizer, and negative probe to OUT-, to check whether there is a fault in the optimizer. If the typical value of the output voltage (U) is 1V, the optimizer has no fault.

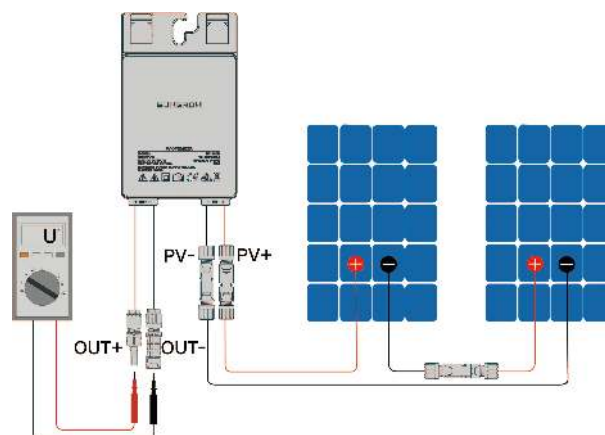

Table 5-1 Output Voltage

Voltage	Possible Cause	Suggestions
$0.9\text{ V} \leq U \leq 1.1\text{ V}$	Nothing abnormal with the optimizer.	/
$U < 0.9\text{ V}$	1. Poor sunlight.	1. Measure the voltage when there is sufficient sunlight.
	2. No PV module is connected to the input side of the optimizer.	2. Connect the PV module to the input side of the optimizer.
	3. The wiring of the optimizer is wrong.	3. Re-connect the optimizer cables correctly. Make sure the input side of the optimizer is connected to the output side of the PV module.
	4. There is a fault in the optimizer.	4. Replace the optimizer.
$U > 1.1\text{ V}$	There is a fault in the optimizer.	Replace the optimizer.

NOTICE

Complete the optimizer wiring and measure the output voltage by following the steps below.

- After completing the wiring of an optimizer, use a multimeter to measure its output voltage. Ensure that the output voltage of each optimizer is within the normal range.
- After confirming that the output voltages of all optimizers are normal, use a multimeter to measure the output voltages of optimizers in the same string.
- If you do not check the optimizer output voltages and confirm the string has been wired properly in this step, in case of something abnormal, you may have to check the whole wiring again, where rework is required.

Step 3 Each optimizer is equipped with four QR code labels on its front and back sides. Remove any one of these labels and affix it to the paper in the logical order of the actual wiring. This allows you to add the optimizer to iSolarCloud by importing an Excel layout file.

Voltage (V)	Possible Cause	Suggestions
	2. The cables are not connected to the same string.	2. Identify the string cables correctly.
U<0	1. The probes are connected reversely.	1. Reconnect the positive and negative probes correctly.
	2. The cable labels are incorrect.	2. Prepare cable labels correctly.
U<0.9*N	1. The input cables of some optimizers are not connected.	Check whether the cables of modules and strings are properly connected.
	2. The output cables of some optimizers are not connected.	
	3. The output cables of some optimizers are connected reversely.	
U>1.1*N	1. The actual number of optimizers in the string is greater than expected.	1. Check whether the number of optimizers in the string is correct.
	2. The PV module is connected to the string directly, not connected to any optimizer.	2. Check whether the cables of modules and strings are properly connected.

Step 5 Connect the OUT+ of the first optimizer and the OUT- of the last one to the DC input terminals of the inverter.

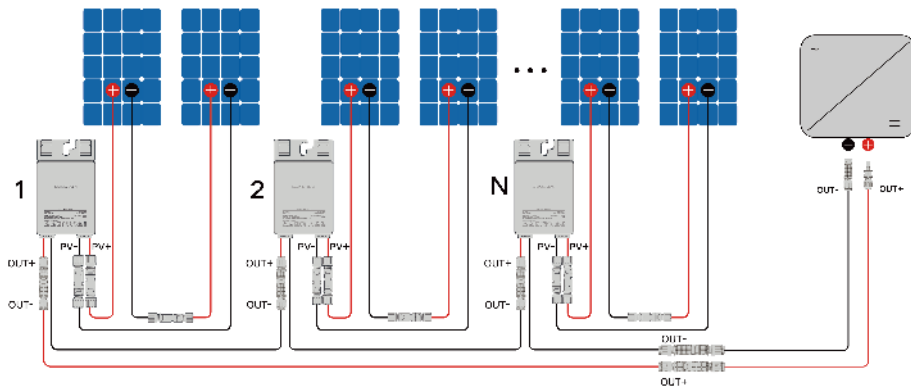

⚠ WARNING

The total power of PV modules in a PV string should not exceed the maximum input power of a single input of the inverter.

NOTICE

- The optimizer supports full-coverage deployment only.
- To deploy the optimizer, the use of Y-type connectors on the input side of the inverter is not supported, as the optimizer is not compatible with such connectors.

--End

5.5 Wiring Notices

Do not coil the optimizer's cable when wiring, given that the communication quality may decline if the extension cable is too long.

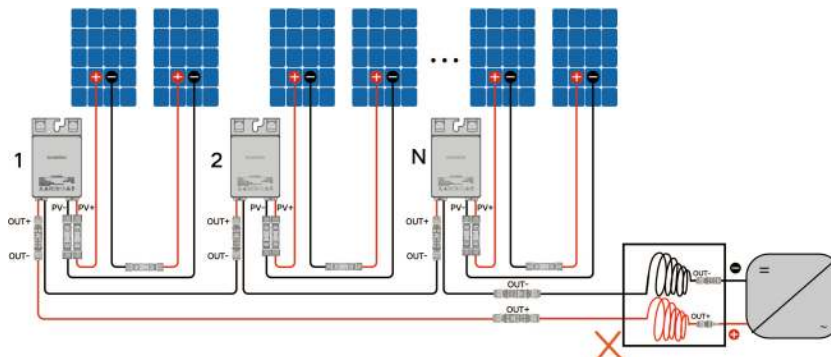

The maximum total length of cables from the inverter input (+) to input (-) is 900 m. If the distance exceeds 900 m, consult SUNGROW first.

⚠ WARNING

DC Wiring Requirements: The positive and negative DC cables of the same PV string should be kept parallel and close to each other. The correct wiring is shown below.

Scenario 1:

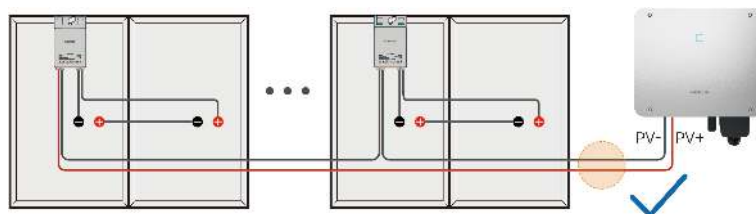

Scenario 2:

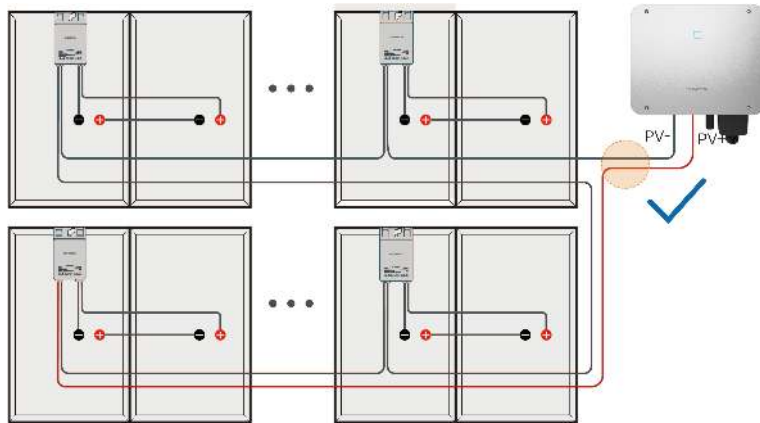

⚠ WARNING
The positive and negative DC cables of the same PV string are not allowed to be laid apart, as shown in the figure below.

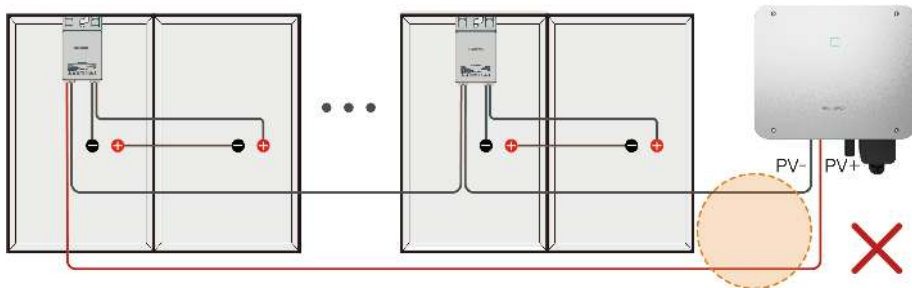

6 Commissioning

6.1 Inspection Before Commissioning

Perform inspections as follows before starting the optimizer for the first time, and make sure the requirements below are all met.

- All devices are properly installed.
- All cables are connected properly in the correct polarity.
- The input and output cables of all optimizers are connected correctly.
- The QR code labels of the optimizers are affixed to the paper in the same order as the optimizers are actually installed.
- Ensure the data logging device (WiNet-S2 or Logger1000) properly communicates with the inverter and other devices. For specific instructions, see the [iSolarCloud App User Manual \(Overseas\)](#) or [Logger1000 User Manual](#).
- All warning signs and labels are intact and legible.
- V2.1.6.20250225 or later versions of iSolarCloud App is used.

6.2 Set Optimizer Physical & Logical Layouts

To set up the physical layout of the optimizers, create a plant on iSolarCloud first. For details on how to create a plant on iSolarCloud, please refer to the *iSolarCloud App User Manual*. Scan the QR code below to get the user manual.



6.2.1 Optimizer Layout Settings (iSolarCloud)

For distributed PV plants, it is recommended to complete the layout settings by importing an Excel layout template. For detailed instructions, refer to Section **4.3.8 Layout Settings** in the iSolarCloud User Manual. The user manual can be accessed by visiting the website or scanning the QR code below.

<https://support.sungrowpower.com/productDetail?directoryId=1714585960925552641>



In the scenario of connection without network, the O&M personnel need to upload a configuration file containing the physical layout information of the inverter and other devices on the Web of the Logger1000 to create a plant. For details, see **10.5 Uploading Physical Layout** in [Logger1000 User Manual](#).

6.3 PLC Communication Setup

By default, communication between the inverter and the optimizer is disabled. After the optimizer is connected to the inverter, enable communication manually to establish the communication link.

Prerequisite

A plant is created via the iSolarCloud App, and the inverter and optimizer are added to the plant.

- Step 1** Tap the plant name to open its overview.
- Step 2** Tap **Device**, then select the inverter.
- Step 3** Choose **Settings** from the top tabs.
- Step 4** Tap **General settings**. Choose **Connect optimizer/RSD or not**, select **Connected**, then tap **Apply settings**.
- Step 5** Tap **Confirm**. The App will display “**Changes applied**” once the setup is successful.

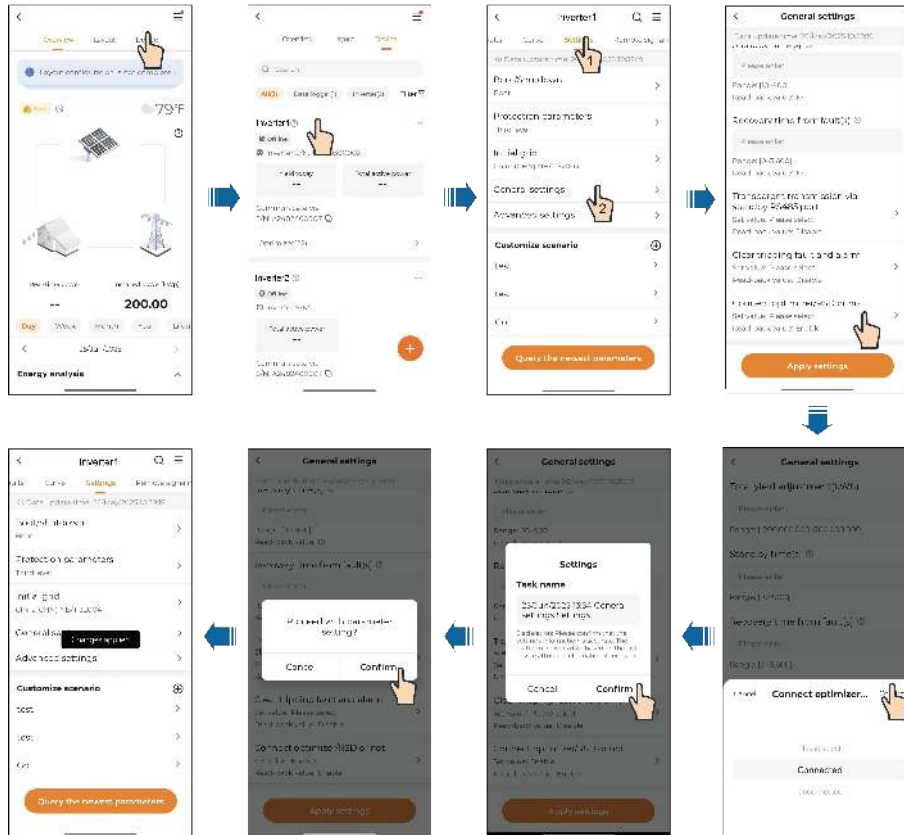

--End



6.4 View Optimizer Layout

6.4.1 Check Optimizer Status

Optimizer Running Status

You can tell the status of the optimizer based on the color of the corresponding PV module in the layout. The table below shows the relation between the PV module color and the optimizer status.

Layout	Status	Cause	Suggestions
	The optimizer is operating normally.	/	/







Layout	Status	Cause	Suggestions
	<p>There is a fault in the optimizer</p>	<ol style="list-style-type: none"> 1. There is a hardware fault in the optimizer. 2. The PV voltage exceeds the preset voltage protection threshold. 	<p>See 8.1 Troubleshooting for troubleshooting methods.</p>
	<p>There is an alarm in the optimizer</p>	<p>optimizer software update has failed.</p>	<ol style="list-style-type: none"> 1. Software update may take more than 20 minutes for a large-scale system with a large number of optimizers. Please check the light condition, and perform software update under good light conditions. 2. If the fault persists, please contact SUNGROW Customer Service.
	<p>The optimizer is offline.</p>	<ol style="list-style-type: none"> 1. The optimizer input connectors are in poor contact. 2. There is a fault in the module attached to the optimizer. 3. The modules attached to the optimizer are shaded. 4. There is a fault in the optimizer. 5. The PV string may be connected with reverse polarity. 	<ol style="list-style-type: none"> 1. Check if the optimizer input cables are properly connected. 2. After powering off*, check whether the voltage of the module is in normal range using a multimeter. 3. Check if the modules are shaded. 3. After powering off, check whether the voltage of the optimizer is in normal range using a multimeter. 5. After powering off, check whether the string voltage is in normal range using a multimeter. If the voltage is negative, check whether the PV

Layout	Status	Cause	Suggestions
			cables are connected with reverse polarity.

NOTICE

*****Power off***: Switch off the external AC circuit breaker of the inverter, and then set the DC switch to "OFF". After that, wait 5–15 minutes, depending on the specific inverter model, until the capacitors inside the inverter are fully discharged.**

The PV module is blue if the optimizer is operating properly. The color shade of a module reflects its power generation efficiency. Darker blue indicates a higher power ratio and greater power generation efficiency.

Color Shade	Actual Power/PV Module Peak Power*100%
	80–100%
	60–80%
	40–60%
	20–40%
	0–20%
	Default

6.4.2 View Layout

Physical layout: The actual arrangement of the PV modules at the site.

Logical layout: The arrangement of PV modules in each string.

Switch between physical layout and logical layout

Tap **Layout** at the top of the screen. You may then choose to view the **Physical Layout** or **Logical Layout**.

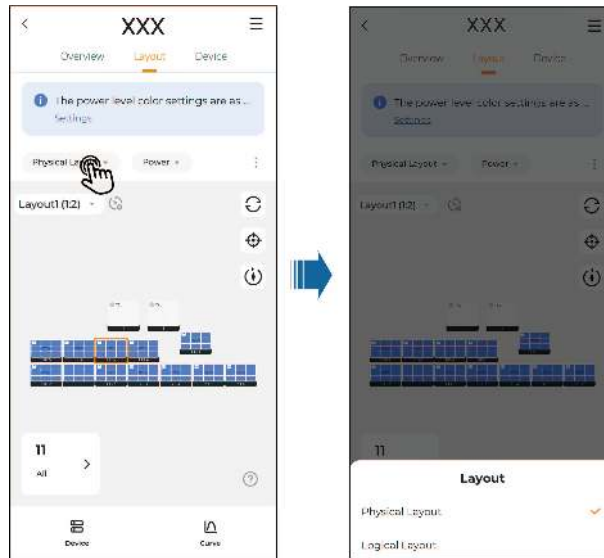

Switch between physical layouts

Tap **Layout1 (1:2)**. You may then switch between physical layouts with different device-to-module ratios.

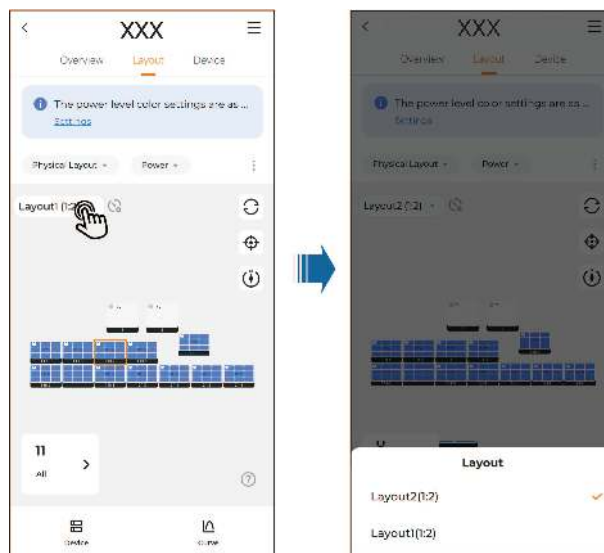

Quickly locate PV modules (for iSolarCloud only)

Double-click a device in the layout. The module associated with this device will also be selected.

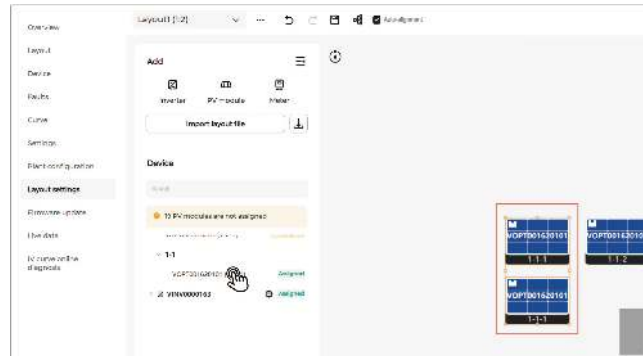

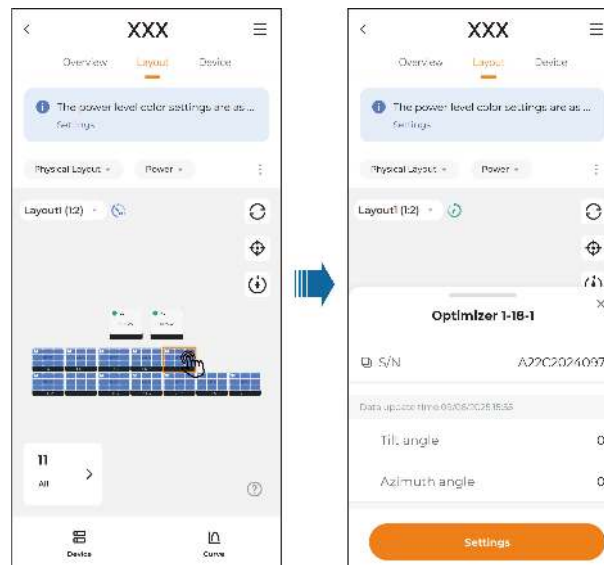

6.4.3 View Module Information

Step 1 Tap a module in the layout to view the device information and running data of the optimizer.

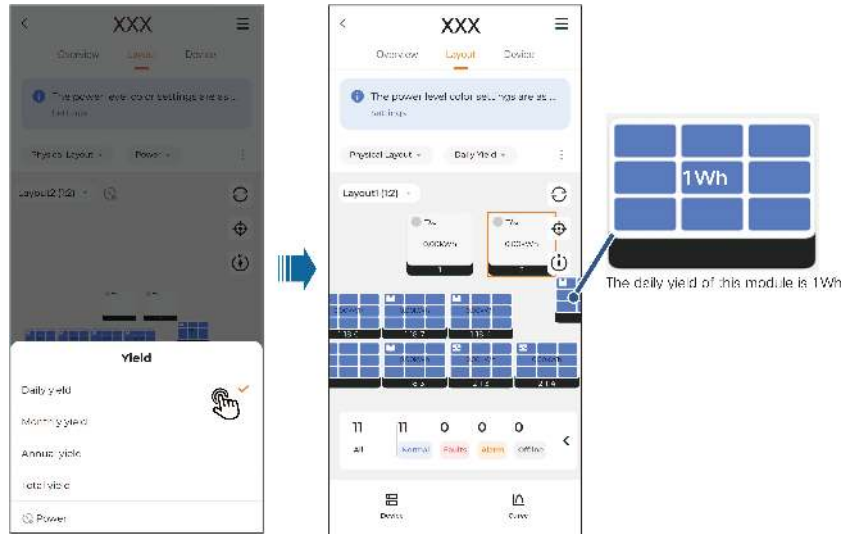

Step 2 Tap **Daily Yield**. You can then choose to check the data on **Daily Yield**, **Monthly Yield**, **Annual Yield**, **Total Yield**, or **Power**. After an option is selected, the corresponding data will be shown on the modules. You can also select **Power** to get the data refreshed at intervals of seconds.



Step 3 To see how the data of a module changes over time, tap  in the lower right corner, select the target module, and tap **Curve**. The data curve of this module will then be shown.

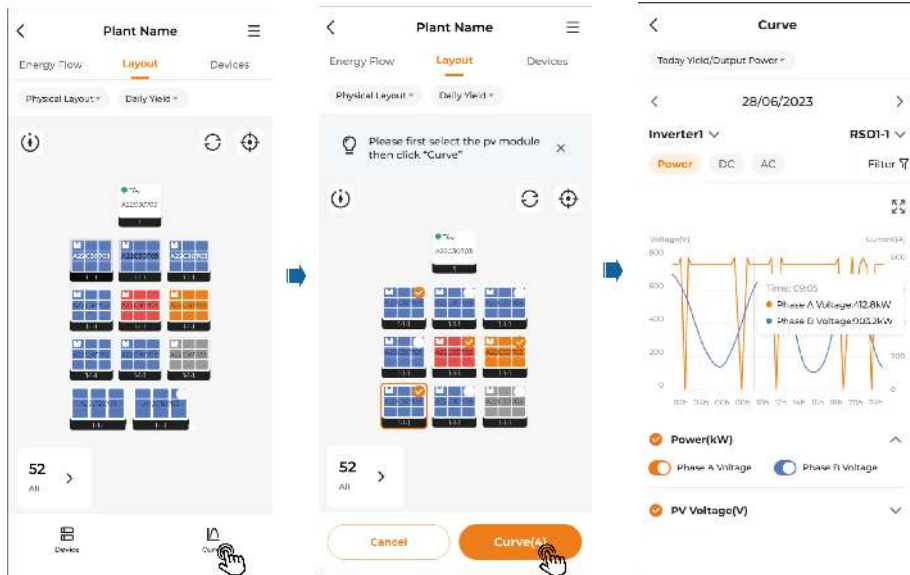

--End

7 Optimizer Decommissioning, Dismantling, and Disposal

7.1 Decommission the optimizer

Prerequisite

CAUTION

Danger of burns!
Even if the optimizer has stopped running, it may still be hot and cause burns.
Perform operations on the optimizer wearing protective gloves after it cools down.

Step 1 The inverter that is connected to the optimizer has been powered off.

Step 2 Test the DC cables using a current clamp and confirm that they are current-free.

--End

7.2 Dismantle the optimizer

Prerequisite

CAUTION

Danger of burns and electric shocks!
After the upstream and downstream devices of the optimizer have been powered off, test the voltage and current using proper measuring instruments. Operations on the optimizer can be performed by qualified persons who wear proper protective equipment after confirming that no voltage or current is present.

Step 1 Disconnect all electrical connections of the optimizer by completing in reverse order the procedure described in [5.4 Optimizer Connection to PV Module](#). To disconnect the DC connector, use a specialized wrench to release the locking element first. Then, fit the waterproof stopper plug.

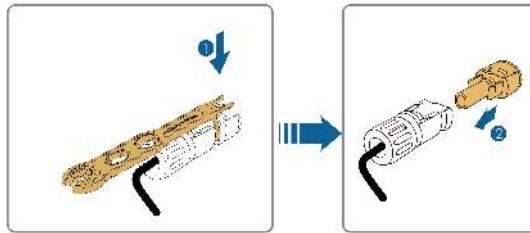

Step 2 If the optimizer will be used again in the future, store it properly by referring to [3.2 Optimizer Storage](#).

--End

7.3 Dispose of the optimizer

Users shall bear the responsibility for optimizer disposal.

⚠ WARNING

Please dispose of the product in accordance with applicable local regulations and standards, to avoid property damages or personal injuries.

NOTICE

Some parts or components of the optimizer may contaminate the environment. Please dispose of them by following the applicable electronic waste disposal regulations in the place where the optimizer is installed.

8 Troubleshooting and Maintenance

8.1 Troubleshooting

If a fault occurs in the optimizer, the fault information will be shown on the iSolarCloud App.

Fault Code	Fault Name	Possible Cause	Corrective Method
4	Input overvoltage	The PV voltage is higher than	Check whether the open-circuit voltage of the PV modules attached to the optimizer exceeds the maximum allowable input voltage of the optimizer.

Fault Code	Fault Name	Possible Cause	Corrective Method
------------	------------	----------------	-------------------

hesitate to purchase this product. If you have any questions, please contact your local distributor.

512	Hardware fault	A hardware	Please contact SUNGROW Customer Service.
-----	----------------	------------	--

Fault Code	Fault Name	Possible Cause	Corrective Method
		d w a r e f a u l t o c c u r s t o t h e o p t i m i z e r .	

8.2 Maintenance

8.2.1 Maintenance Notices

DANGER

Risk of personal injury or device damage due to improper servicing!

- Be sure to use specialized insulated tools when performing high-voltage operations.
- Before maintenance, power off the input and output sides first, then test the voltage and current using the specialized measuring instrument. Maintenance can be carried out by qualified persons who wear proper protective equipment only after confirming that no voltage or current is present.
- Danger of burns due to a hot surface still exists even if the product has stopped running. Perform operations on the product wearing protective gloves after it cools down.

WARNING

In case of a fault in the product during its operation, before powering on again, make sure the fault has been removed. Otherwise, it may cause the influence of the fault to spread or device damages.

CAUTION

To prevent irrelevant personnel from operating the product by mistake or other accidents, please set up highly visible warning signages around the product or fence off a warning zone.

NOTICE

The optimizer contains no components or parts that can be maintained. Do not open its enclosure or replace any of its internal components. To minimize the risk of electric shocks, do not perform maintenance operations that are not specified in this manual. If necessary, contact SUNGROW for maintenance. Losses arising from failure to observe this instruction will not be covered by warranty.

NOTICE

Touching the PCB or other static-sensitive components may lead to device damages.

- Do not touch the circuit board unnecessarily.
- Observe the specifications for protection against electrostatic discharges and wear an anti-static wrist strap.

8.2.2 Routine Maintenance

The maintenance item and period of the device are listed in the table below.

Check Item	Check Method	Maintenance Period
Running status	Check whether the device operates normally. Check whether there is abnormal noise or sound during operation.	Once every six months
Electrical connection	Check whether cables are loose or fall off. Check whether cables are damaged.	Once every six months to a year

8.2.3 Rapid Shutdown

Support module level rapid shutdown. 20s module-level rapid shutdown for residential application and 30s module-level rapid shutdown for C&I application.

Triggering methods of rapid shutdown:

- Method 1: Turn off the AC circuit breaker between the inverter and the grid.
- Method 2:
Connect a rapid shutdown button to the DI emergency stop buttons of the inverter to form a circuit. Press this button to trigger a rapid shutdown. Release the button for the inverter to start operation again.
- Method 3: Connect the rapid shutdown button to any DI port (except DI5) on the Logger1000. Then, log in to the Logger1000 web system and configure the DI port parameters. After this, rapid shutdown can be triggered by pressing the rapid shutdown button.
- Method 4: Enable "AFCI-Triggered Rapid Shutdown" manually. Then, in case of an arc fault determined in the inverter, a "rapid shutdown" signal will be sent to the optimizer and the inverter will execute the "press to shut down" and "rapid shutdown" commands simultaneously.

NOTICE

- **The rapid shutdown function is not supported if optimizers are configured for partial MPPT deployment scenario.**
- **The optimizer's rapid shutdown function is not available for SH3.0/3.6/4.0/5.0/6.0RS inverters.**
- **Please check regularly whether the rapid shutdown function is normal.**
- **Rapid shutdown cannot be achieved by turning off the inverter's DC switch.**

8.2.4 Replace the optimizer

Step 1 The inverter connected to the optimizer has been powered off (AC side), and DC switches have been then turned off.

Step 2 Check and confirm that the DC cables are current-free using a current clamp.

Step 3 Disconnect all the electrical connections of the optimizer. When disconnecting the DC connector, use an MC4 wrench to release the locking element first, and then fit the waterproof stopper plug.

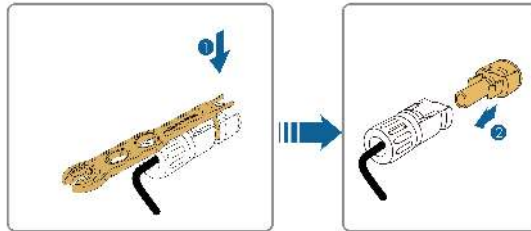

Step 4 Replace the optimizer. Mount the optimizer and complete the wiring by referring to [5.4 Optimizer Connection to PV Module](#).

Step 5 Power on the inverter. Log in to the iSolarCloud App. Tap the plant name from the plant list on the **Monitoring** screen. Then, on the **Device** screen, choose “optimizer” at the bottom of the inverter card. Find the S/N of the optimizer to be replaced, and tap **Replace** below.

Enter the S/N of the new optimizer, or tap  to scan the QR code on its enclosure. Then, tap **Start Replacement**.

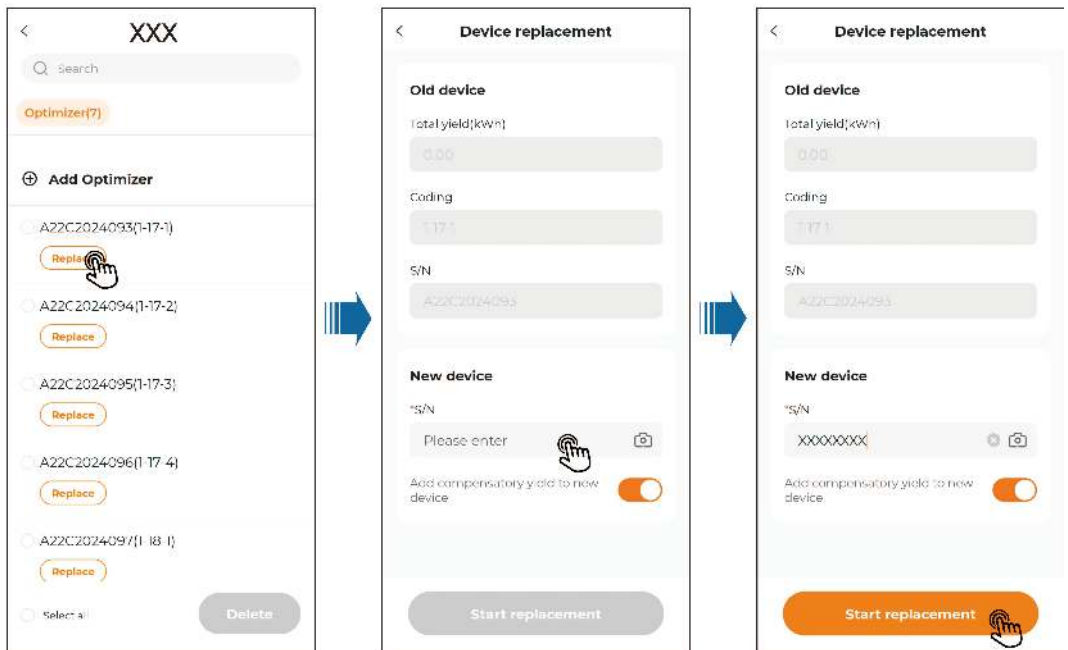
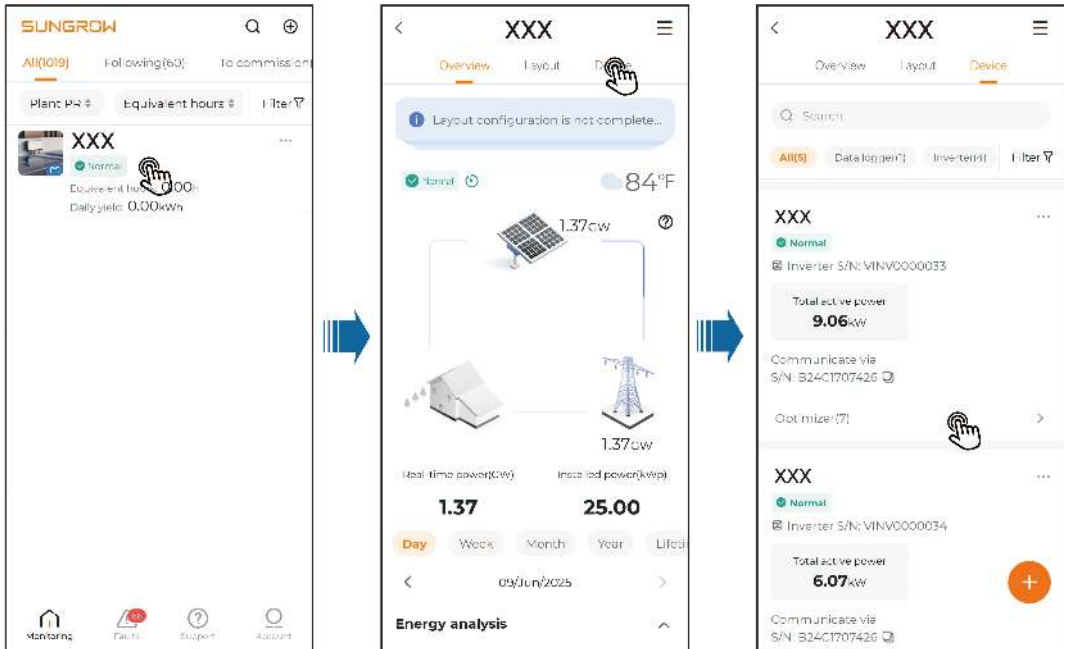

i After replacement, the new device will take the place of the old device in the layout automatically and thus does not need to be added again.

--End

9 Appendix

9.1 Technical Data

Type designation	SP1200D	SP1400D
Input		
Max. input voltage	125 V	
MPPT voltage range	12.5V – 105V	
Max. DC short-circuit current per channel (Isc)	30 A	
Max. system voltage	1100 V	
Overvoltage category	II	
Output		
Rated output power	1200 W	1400 W
Max. output current	23 A	
Bypass working mode	Yes	
Safety output voltage	1 V	
Efficiency		
Max. efficiency	99.5 %	
Weighted efficiency	99.0 %	
General date		
Dimensions (W * H * D)	143 mm *86 mm * 53mm	
Weight (including cables)	1.0 kg	
Degree of protection	IP68	
Allowable relative humidity range (non-condensing)	0 % - 100 %	
Operating ambient temperature range	-40°C- 85°C	

Type designation	SP1200D	SP1400D
Max. operating altitude	4000 m	
Mounting method	Snap-fit or bolt installation	
Communication	PLC (≤ 450 m)	
PV input / output connector	Stäubli MC4 / MC4 compatible(Optional)	
PV input wire length	1.4 m (+ / -)	
Out put wire length	0.2 m (+) / 2.95 m (-)	
Standard compliance	IEC 61000-6-2, IEC 61000-6-3, IEC 62109-1 (class II safety),IEC 60529	
Compatible products	SG25 / 30 / 33 / 36 / 40 / 50CX-P2 ⁽¹⁾ SG125CX-P2 ⁽¹⁾	
Configuration		
Number of supported PV modules in one string	8-50	
The difference in the number of optimizers between parallel strings under the same MPPT path ⁽¹⁾	Parallel strings are not supported. Only one string of optimizers is supported under a single MPPT.	
Maximum number of optimizers supported by a single communication device	240: Winet-S2 4900 ⁽²⁾ : Logger1000 / Logger1000-EU	

The table below provides the recommended configurations for systems with SP1200D and SP1400D optimizers.

Type designation	SG125C X-P2	SG50CX -P2	SG36CX -P2	SG33CX -P2	SG30CX -P2	SG25CX -P2
Max No. of Optimizers per string	25	25	25	25	25	25

Type designation	SG125C X-P2	SG50CX -P2	SG36CX -P2	SG33CX -P2	SG30CX -P2	SG25CX -P2
Min No. of Optimizers per string	4	4	4	4	4	4
Max. Power limitation per string	19.5 KW	19.5 KW	19.5 KW	18.4 KW	18.4 KW	18.4 KW
No. of Strings per inverter						
DC: AC Ratio <1.1	7-12	3-4	2-4	2-3	2-3	2-3
DC: AC Ratio 1.1-1.3	7-12	3-4	2-4	2-3	2-3	2-3

(1): Please consult Sungrow before placing an order on optimizers and compatible inverters.

(2): Please use multiple Logger1000 when over 4900 optimizers. Please connect to two RS485 ports when over 3000 optimizers for single Logger1000.

9.2 Quality Assurance

When product faults occur during the warranty period, SUNGROW will provide free service or replace the product with a new one.

Evidence

During the warranty period, the customer shall provide the product purchase invoice and date. In addition, the trademark on the product shall be undamaged and legible. Otherwise, SUNGROW has the right to refuse to honor the quality guarantee.

Conditions

- After replacement, unqualified products shall be processed by SUNGROW.
- The customer shall give SUNGROW a reasonable period to repair the faulty device.

Exclusion of Liability

In the following circumstances, SUNGROW has the right to refuse to honor the quality guarantee:

- The free warranty period for the whole machine/components has expired.
- The device is damaged during transport.
- The device is incorrectly installed, refitted, or used.
- The device operates in harsh conditions beyond those described in this manual.
- The fault or damage is caused by installation, repairs, modification, or disassembly performed by a service provider or personnel not from SUNGROW.
- The fault or damage is caused by the use of non-standard or non-SUNGROW components or software.
- The installation and use range are beyond stipulations of relevant international standards.
- The damage is caused by unexpected natural factors.

For faulty products in any of above cases, if the customer requests maintenance, paid maintenance service may be provided based on the judgment of SUNGROW.



Product data such as product dimensions are subject to change without prior notice. The latest documentation from SUNGROW should take precedence in case of any deviation.

9.3 Contact Information

In case of questions about this product, please contact us. We need the following information to provide you the best assistance:

- Model of the device
- Serial number of the device
- Fault code/name
- Brief description of the problem

For detailed contact information, please visit: <https://en.SUNGROWpower.com/contactUS>

SUNGROW

Sungrow Power Supply Co., Ltd.

www.sungrowpower.com